

OWNER'S MANUAL

THE BREAD MACHINE

From Sandwich Breads to Specialty Breads
Easy and Delicious — Right at Your Table

MODEL **ABM-100-4**

Please take a few minutes to read these instructions before use. By carefully following the instructions, your Home Baker will serve you long and well.

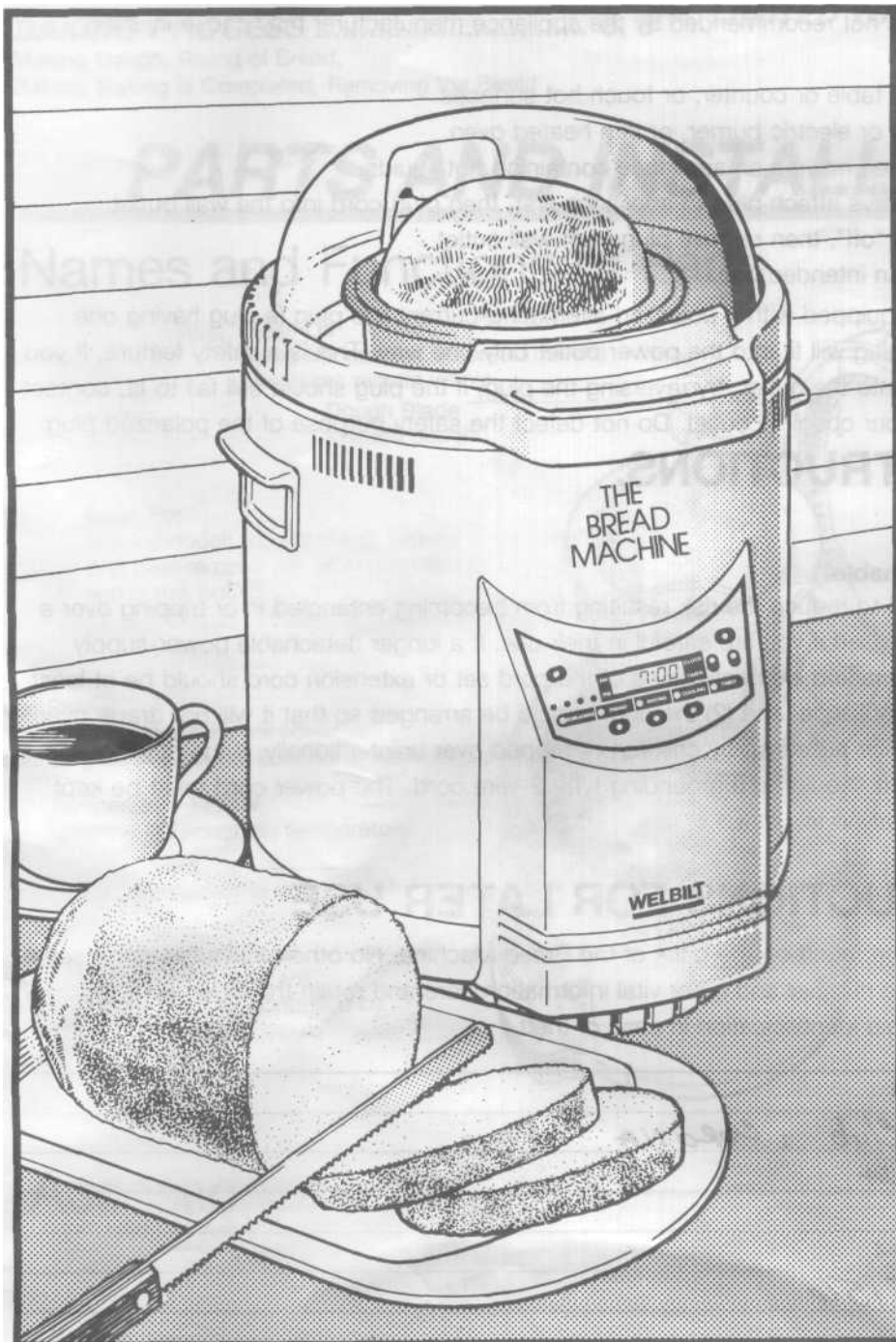

WELBILT®

IMPORTANT SAFEGUARDS

HOUSEHOLD USE ONLY

When using electrical appliances, basic safety precautions should always be followed, including the following:

1. Read all instructions before using the appliance.
2. Do not touch hot surface. Use handles or knobs.
3. To protect against electrical shock do not immerse cord, plugs, or unit in water or other liquid.
4. To prevent injuries or burns, do not insert your hand into appliance when appliance is operating.
5. Close supervision is necessary when any appliance is used by or near children.
6. Unplug from outlet when not in use and before cleaning. Allow to cool before putting on or taking off parts.
7. Do not operate any appliance with a damaged cord or plug or after the appliance malfunctions, or has been damaged in any manner. Return appliance to the nearest authorized service facility for examination, repair, or adjustment.
8. The use of accessory attachments not recommended by the appliance manufacturer may cause injuries.
9. Do not use outdoors,
10. Do not let cord hang over edge of table or counter, or touch hot surfaces.
11. Do not place on or near a hot gas or electric burner, or in a heated oven.
12. Extreme caution must be used when moving an appliance containing hot liquids.
13. When using an extension cord always attach plug to appliance first, then plug cord into the wall outlet. To disconnect, turn any control to "off", then remove plug from wall outlet.
14. Do not use appliance for other than intended use.
15. Polarization — This appliance is equipped with a polarized alternating-current line plug (a plug having one blade wider than the other). This plug will fit into the power outlet only one way. This is a safety feature, if you are unable to insert the plug fully into the outlet, try reversing the plug, if the plug should still fail to fit, contact a qualified electrician to replace your obsolete outlet. Do not defeat the safety purpose of the polarized plug.

SAVE THESE INSTRUCTIONS.

A short power-supply cord for detachable

This unit has a short power supply cord to reduce the risk resulting from becoming entangled in or tripping over a longer cord. An extension cord may be used if you are careful in their use. If a longer detachable power-supply cord or extension cord is used, (1) the marked electrical rating of the cord set or extension cord should be at least as great as the electrical rating of the appliance, and (2) the cord should be arranged so that it will not drape over the countertop or tabletop where it can be pulled on by children or tripped over unintentionally. If the appliance is of the grounded type, the extension cord should be a grounding type 2-wire cord. The power cord must be kept dry and must not be bent or anything put on top of it.

SAVE THESE INSTRUCTIONS FOR LATER USE

The serial number of this product may be found on the back of the Bread Machine. No others have the same serial number as yours. You should record the number and other vital information here and retain this book as a permanent record of your purchase to aid identification in case of theft.

Date of Purchase	
Dealer Purchase from	
Dealer Address	
Dealer Phone No.	
Model No.	ABM-100-4
Serial No.	

CONTENTS

PARTS AND INSTALLATION.....3 Names and Functions of Parts, Accessories	SAFETY INSTRUCTIONS.....10, 11 Baking Process, Power Supply, Suitable Locations, Main Unit, Oven, Handling of the Unit, If Power Goes off During Use, Consult Qualified Service Personnel if the Following Occurs
CONTROL PANEL.....4, 5 THE TIMER Setting the Present Time, Using the Timer to Make Bread	CARE OF YOUR AUTO BAKERY.....12 Inner Pot, Dough Blade, Shaft, Packing, Oven, Air Intake, Main Unit
MAKING VARIOUS TYPES OF BREAD .. 6 Menu Selection, Mounting the Inner Pot	BEFORE ASKING FOR SERVICE.....13
BREAD MAKING.....7 Full Auto cycle. Making Special Kinds of Bread, Manual cycle for Homemade Bread,	FEATURES, SPECIFICATIONS.....14
BAKING PROCESS.....8, 9 Making Dough, Rising of Bread, Baking, Baking is Completed, Removing the Bread	LIMITED WARRANTY.. .15

PARTS AND INSTALLATION

Names and Functions of Parts

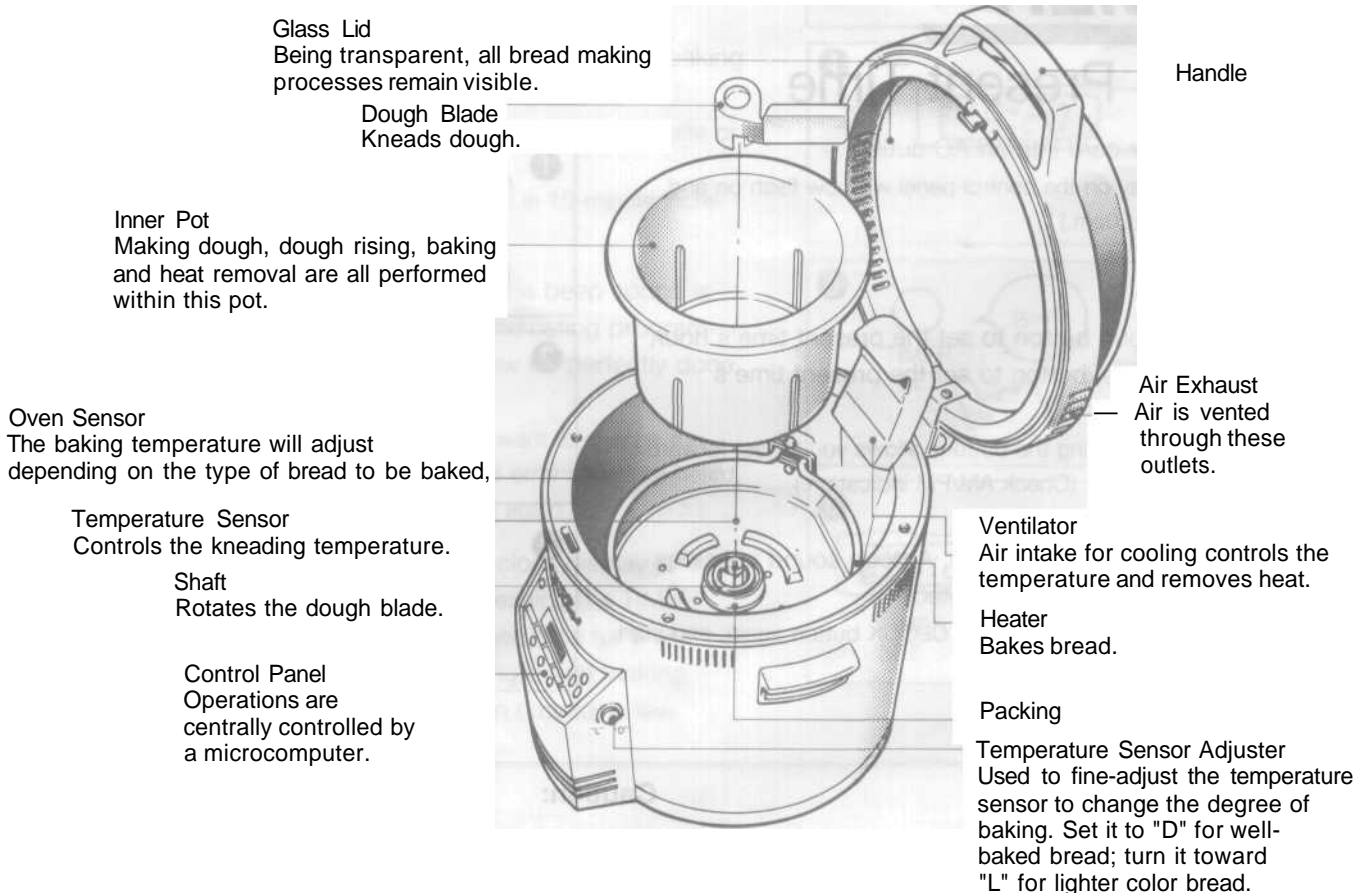

Accessories

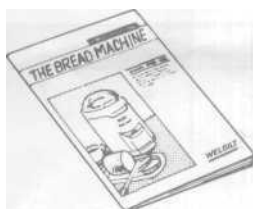

Owner's Manual



Baking Guide

CONTROL PANEL

- SWEET BREAD IND. LIGHT
- ◎ MANUAL MODE IND. LIGHT
- ◎ AM IND. LIGHT
- PM IND. LIGHT
- DISPLAY WINDOW
- ◎ TIMER STANDBY MODE IND. LIGHT
- CLOCK MODE IND. LIGHT
- ◎ CLEAR/STOP BUTTON
- ◎ MINUTE BUTTON
- ◎ HOUR BUTTON

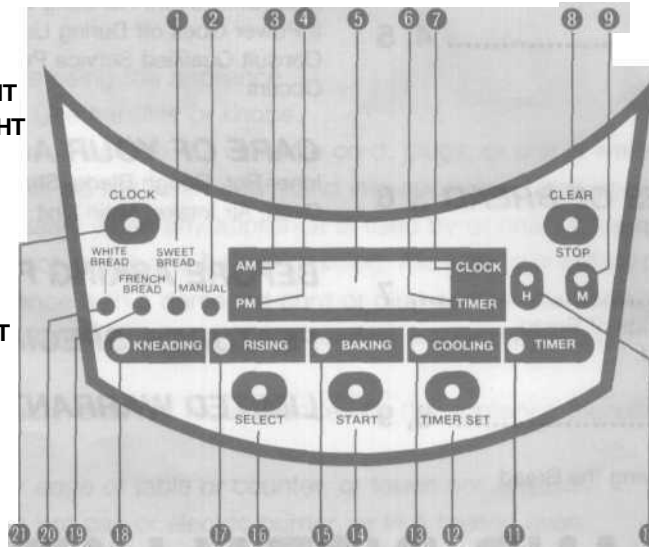

- ◎ TIMER SET IND. LIGHT
- ◎ TIMER MEMORY SET BUTTON
- ◎ COOLING IND. LIGHT
- ® START BUTTON
- ◎ BAKING IND. LIGHT
- ◎ MENU SELECT BUTTON
- ◎ RISING IND. LIGHT
- ◎ KNEADING IND. LIGHT
- ◎ FRENCH BREAD IND. LIGHT
- ◎ WHITE BREAD IND. LIGHT
- ® CLOCK SETTING BUTTON

THE TIMER

Setting the Present Time

- 1 Plug the power cord into an AC outlet.
(The clock display on the control panel will now flash on and off indicating 12:00am.)
- 2 Press the H(Hour) button to set the present time's hour, and the M(Minute) button to set the present time's minutes.
 - Continuously pressing the buttons allows you to fast forward to the time desired. (Check AM/PM indication.)
- 3 Now press the CLOCK button. A beep sound indicates present time setting is completed.
 - In case of a mistake, press the CLOCK button again, and start again from step 2.

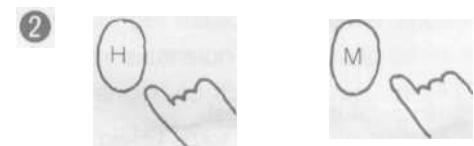

Note: Time Setting

To prevent the quality of ingredients from deteriorating, the timer cannot be programmed for periods over 12 hours. As process usually requires approx. 4 hours and 20 minutes, a time setting of less than 4 hours and 20 minutes cannot be performed. A mistake during setting will generate "long beep" error sound. In this case, reset the time display to read the correct time.

Caution:

Do not operate the unit immediately after baking is completed or when temperature inside of oven is higher than 122°F (50°C). Otherwise the microprocessor will not activate the Bread Machine.

Using the Timer to Make Bread

1 Select the type of bread to be baked with the SELECT button.

Note: Do not use the program timer when making bread containing ingredients that can easily spoil, such as egg, milk, vegetables and grains such as oatmeal etc.

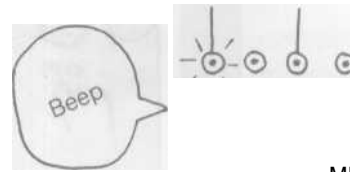

MENU

2 Check the present time on the display.

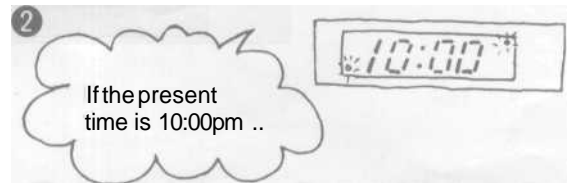

3 Press the TIMER SET button.

(Check to make sure the timer display lights up.)

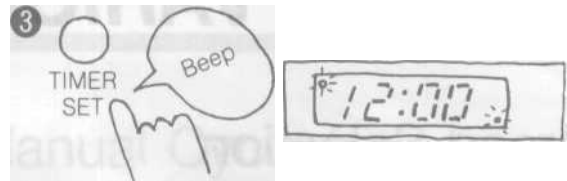

4 Set the hour and minute for the time you want the baking to be finished.

(Follow the same procedure as that used for setting the time of day.)

Note: The program timer can only be adjusted in 10-minute increments.



5 Press the TIMER SET button again. The beep sound is heard and the timer lamp lights up, indicating programming is completed. The bread will now be perfectly done at the programmed time.

(If you made a mistake during setting or want to change the programmed time, or should a long beep error sound be heard, press the CLEAR/STOP button and start again from step 3.)

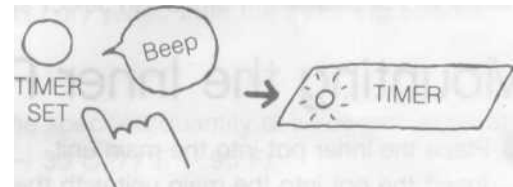

6 After programming is completed, the clock display returns to indicate the current time of day. Pressing the TIMER SET button will display the programmed time for 3 seconds. Pressing the 'start' button during bread making process will display baking completion time for a few seconds.

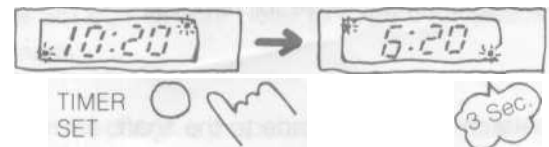

For example...

Program timer cannot be set for
(4 hours, 20 minutes)

Time for which the program timer may be set

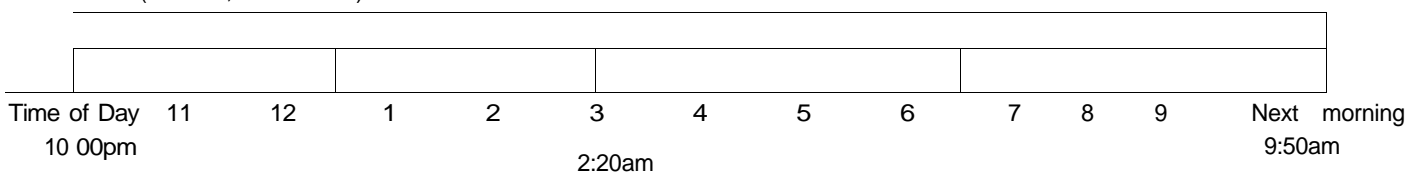

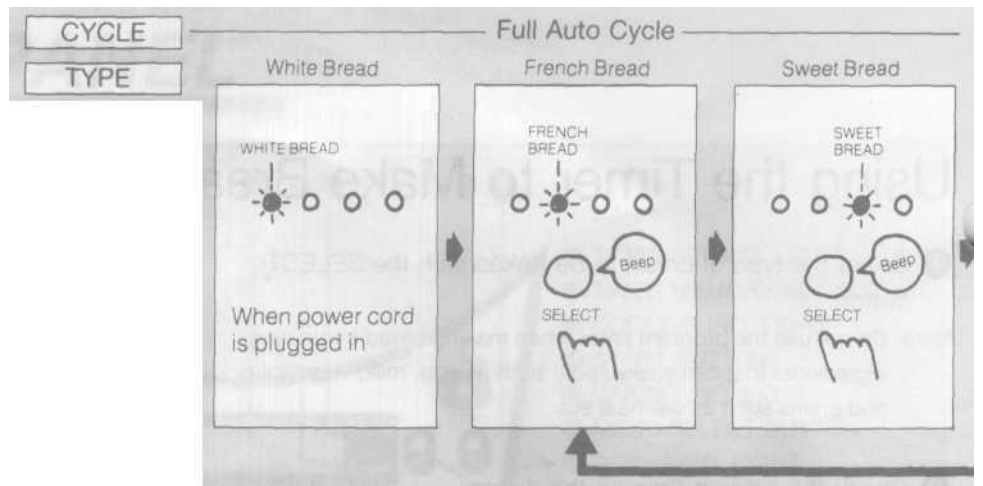

MAKING VARIOUS TYPES OF BREAD

Bread Selection

- When the SELECT button is pressed, the Select light shifts as shown above, so that your desired type of bread will be selected.
Make sure that the desired Select light is lit before pressing the START button.
- White bread, french bread and sweet bread are automatically baked.
- For breads and other yeast dough items to be baked in a conventional oven, SELECT button is pressed until MANUAL light is lit. Press button again until light for desired bread dough is simultaneously lit. For example: For Danish select sweet bread, For bagels select white bread, etc.

Mounting the Inner Pot

- 1 Place the inner pot into the main unit.
Insert the pot into the main unit with the arrow facing front, and turn clockwise to lock into place securely. Turn the inner pot counterclockwise for removal.
- 2 Attach the dough blade to the shaft.
Make sure all bread crumbs are removed after each use and firmly attach to the shaft.
 - Wash the dough blade and the inner pot before use with a soft sponge. Be sure to rinse well with water after each use.

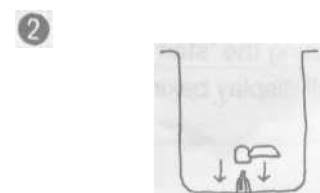
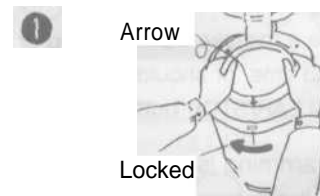

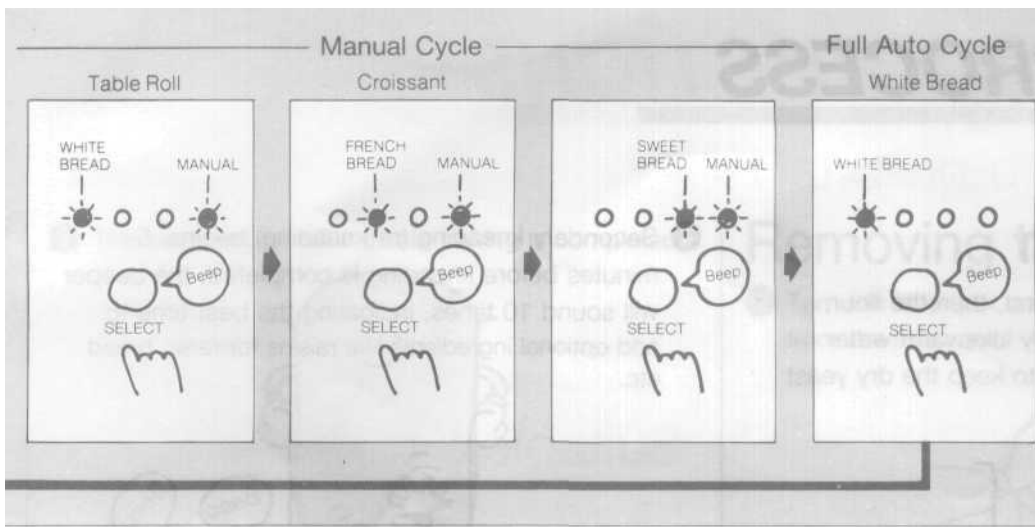

BREAD MAKING

Full Auto Cycle

- 1 Check to make sure the inner pot is correctly positioned.
Prepare and add the ingredients for the bread.

Note: Adding Yeast

For better baking results, add yeast near the edge of the inner pot. (See page 8, step ©.)

- 2 First add the dry yeast, then the other ingredients into the inner pot.
- 3 Add the specified quantity of lukewarm water at 25°C ~ 35°C (77°F ~ 95°F).
- 4 Press the SELECT button to select your desired bread.
- 5 Press the START button for immediate baking.
Your bread will be ready in about 4 hours.
When using the program timer, set the timer following the procedure on page 5.

Making Special Kinds of Bread

Raisin bread, rye bread and other types of bread can also be baked.

Manual Cycle for Homemade Bread

The process for just making dough is performed with this cycle.

- 1 Mix the ingredients for the desired type of bread.
- 2 First add dry yeast, then the other ingredients.
- 3 Add the specified quantity of lukewarm water at 25°C ~ 35°C (77°F ~ 95°F).
- 4 Select your desired Manual bread by pressing the SELECT button. Refer to page 6 for selecting breads.
- 5 When the dough is prepared, remove it from the inner pot and let it rise in the shape you desire.
- 6 After the bread rises, bake it in your oven.
Note: Pressing the Start button during the bread making process will display the baking completion time.

Hint:

If the dough rises up to the glass lid, or collapses when the baking process begins, adjust the recipe as explained in the "Suggestions and Hints" section of the recipe booklet.

BAKING PROCESS

Making Dough

- 1 Always put the dry yeast first, then the flour, other ingredients, and lastly lukewarm water into the inner pot in order to keep the dry yeast active.

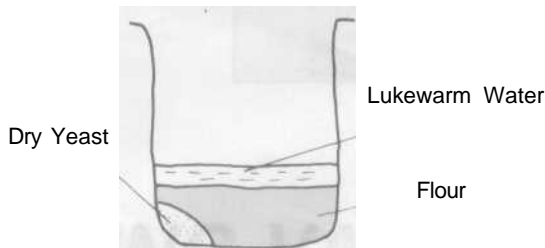

Caution:

Always use soft, lukewarm water. If hard water is used, dough may not rise enough.

- 2 Press the START button to begin the primary kneading of dough.

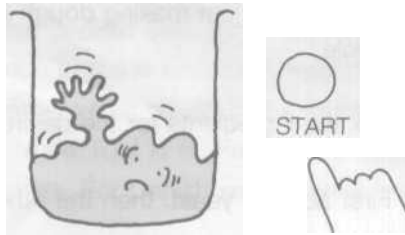

- 3 Kneading stops, and dough begins to rise.

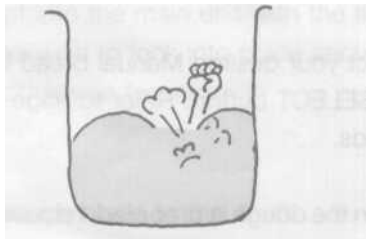

Note:

Water Temperature and Yeast

Yeast is a delicate organism that is easily influenced by temperature changes. For bread to be delicious, it is important that the yeast should function as effectively as possible. The optimum water temperature for yeast is 25°C ~ 35°C (77°F ~ 95°F).

- 4 Secondary kneading (re-kneading) begins. 5 minutes before kneading is completed, the beeper will sound 10 times, indicating the best time to add optional ingredients like raisins for raisin bread etc.

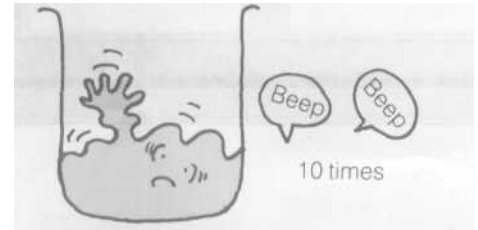

Rising of Dough

- 5 The rising of the dough begins again.

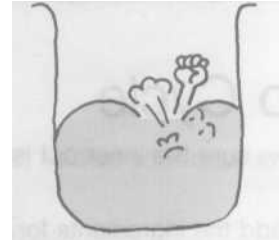

- 6 The dough blade rotates, gathering all the dough.

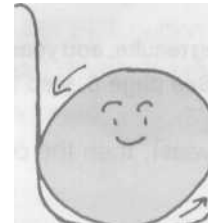

- 7 The final rising of the dough is carried out.

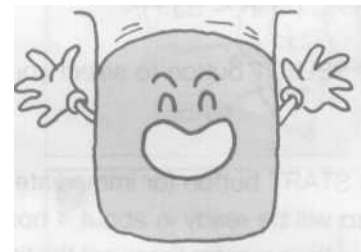

Baking

- 8 The heater is turned on.



9 The beep sound will indicate baking is completed.

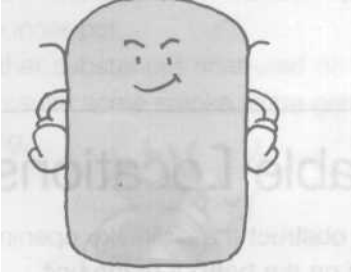

When serving bread that is just baked, take the bread out from the inner pot first. (Make sure you use oven mitts, towels etc., because the temperature is so high.) Dissipate heat by placing a towel or other cloth under the bread before cutting.

Baking is Completed

10 Air is taken in through the air duct for approx. 20 - 30 minutes to remove heat.

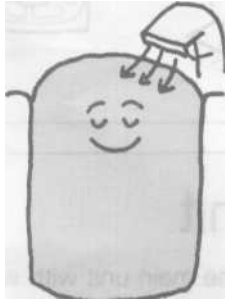

11 The beep sound indicates baking is completed. Take the bread out.

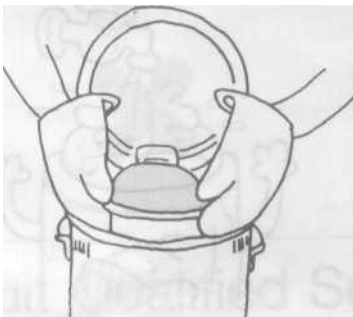

Removing the Bread

12 Turn the inner pot counterclockwise to remove it from the main unit.



13 Place the inner pot upside down to carefully remove the baked bread.

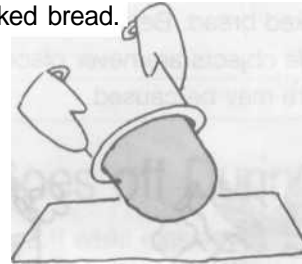

14 Gently remove dough blade which is stuck to the bread.



15 Cut the bread as desired and serve.

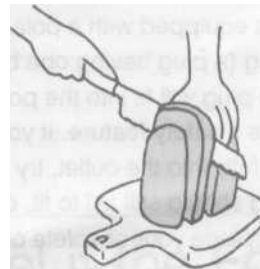

Note:

Removal of Heat

The key to baking flavorful bread is efficient heat removal (cooling). Steam can cause the bread to crumble and rob the bread of its aromatic flavor.

SAFETY INSTRUCTIONS

Baking Process

- Do not touch the glass lid as the temperature becomes extremely high when the unit starts the baking process, or immediately after baking is done. Take special care if infants and children are nearby. Always use hot-pad mitts when taking out fresh-baked bread. Be especially careful that flammable objects are never placed on top of the unit as fire may be caused.



Suitable Locations

- Do not obstruct the air intake opening which is located on the bottom of the unit.
- Do not use the unit near any fire-causing objects, in places exposed to rain or direct sunlight, or other inappropriate places, as it may cause the unit to malfunction or be damaged.



Power Supply

- Only use correctly wired outlets.
- Never share the same outlet with other appliances.
- Remove the plug if the unit is not to be used for an extended period of time.
- Your product is equipped with a polarized alternating current line plug (a plug having one blade wider than the other). This plug will fit into the power outlet only one way. This is a safety feature. If you are unable to insert the plug fully into the outlet, try reversing the plug. If the plug should still fail to fit, contact your electrician to replace your obsolete outlet. Do not defeat the safety purpose of the polarized plug.

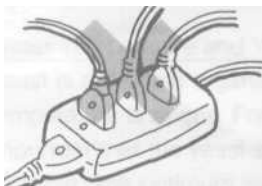

Main Unit

- Do not wash the main unit with water, as this could lead to electrical shock, electrical leakage or other malfunctions.



Oven

- Flour, bread crumbs or any foreign matter accumulated in the oven may make it impossible to insert the inner pot.
- Flour and other substances scattered on the heater may cause some smoke to be generated during baking.



Handling of the Unit

- Do not drop or transmit strong shocks to the unit as malfunctions could result.
- This unit is exclusively designed for bread making. Do not place any other ingredients than used for bread making in the unit.



If Power Goes off During Use

- If the power is cut off while making bread due to power failure, unplugging, etc., the bread making process will be discontinued. In this case, remove the ingredients from the inner pot, replace with new ingredients, and start again from the beginning.
- Please note that if the power is cut off during the programmed time, the clock display will flash 12:00 on and off, making it impossible to continue bread making.

Consult Qualified Service Personnel if the Following Occurs;

- When damage or an abnormality is found in the power cord.
- When the unit operates improperly.
- When the plug's temperature increases alarmingly during use.
- When unusual conditions occur.

CARE OF YOUR AUTO BAKERY

Inner Pot and Dough Blade

- Clean these parts thoroughly using a sponge or soft cloth dampened in lukewarm water. After cleaning, dry completely and store inside the main unit.

Note: The inner pot and dough blade are fluorine resin-coated. To keep the coating from getting scratched and damaged, only use plastic utensils.

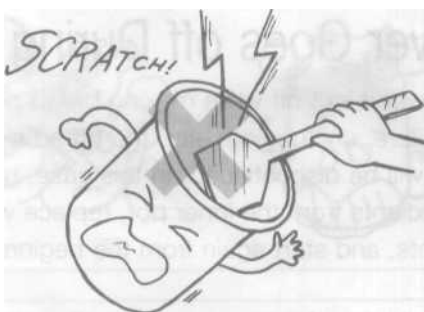

Main Unit

- Unplug the power cord from the AC outlet before cleaning.
- Gently wipe dirt off with a sponge or soft cloth dampened with detergent. Next wipe with a dry cloth.
- Never use harsh cleansers, chemicals or abrasive cleaners. Nylon and metal brushes cannot be used.
- Non-kitchen detergents or bleach should not be used.



Shaft

- Remove all crumbs after each use. Use a sponge or cloth dampened in lukewarm water and squeezed out.

Packing

- If crumbs accumulate on the bottom of the main unit, remove the packing and clean thoroughly with a sponge or soft cloth.
- Be sure to reinstall the packing properly or water may leak.



Oven

Remove flour and bread crumbs and all foreign matter, etc. from the inside of the oven, using a vacuum cleaner first. Next wipe off with a cloth dampened in water and tightly squeezed.

Air Intake

Occasionally clean the air intake filter situated on the unit's bottom to prevent it from clogging. Use vacuum cleaner crevice tool or soft brush to do this.

BEFORE ASKING FOR SERVICE

Problem	Cause	Solution
The unit does not start.	Is the power cord plugged in?	If not, plug the power cord in securely.
	Does the clock display indicate OEO2?	The unit will not operate if the oven's interior temperature is above 122°F — such as immediately after baking is done. Open the lid and let the inside cool off.
	Does the clock display indicate OEO1?	If so, contact qualified personnel.
Water leaks from the inner pot.	Is the inner pot mounted correctly?	If not, mount the inner pot correctly.
	Is the packing of the shaft normal?	If not, contact service personnel and replace the packing.
Dough kneading cannot be performed.	Is the dough blade attached correctly?	If not, remove the inner pot, take out ingredients, and attach the dough blade correctly.
Smoke is generated during baking.	Have flour or other ingredients spattered over the heater in the oven burned?	If so, clean the inside of oven. If smoke results from any other cause than the above, unplug the power cord and contact service personnel.
Dough does not stretch enough.	Is the amount of water used correct? Is the temperature of the water correct?	Use the correct temperature and correct amount of lukewarm water. (25°C ~ 35°C/77°F ~ 95°F)
	Does the clock display read HEO2?	Contact qualified service personnel.
	Are the ingredients used and their composition correct?	Check to make sure that the ingredients and their compositions are correct.
	Is the yeast you are using old or has it been left for a long time with the package opened? Has it been stored incorrectly?	Use fresh yeast from an unopened package.
	Is the bread being baked where the temperature is excessively high or low?-	Use the unit in locations where the temperature is normal.
Bread rises too much or collapses.	High humidity and or high temperatures.	Reduce yeast to 1 1/2 tsp and water to one cup plus up to 4 tbsps.
Bread cannot be baked.	Is the Manual cycle being used?	The Manual course is designed just for dough making and the unit will not enter the baking process. Remove the ingredients, replace with new ingredients, and start the unit in the correct cycle.
	Is the dough blade properly attached?	If not, attach the dough blade correctly.
	Does the clock display read HEO1 or HEO2?	Contact qualified service personnel.
	Was glass cover opened during baking?	Keep the glass cover closed during baking.
Bread cannot be baked with the program timer.	Does the clock display indicate the present time?	Correctly set to read the current time of day.
	Is the program timer set correctly?	Carefully read instructions for setting the program timer on page 4.
	Does the clock display flash on and off reading 12:00?	A power failure may have occurred. Remove ingredients and start all over.
The program timer cannot be set.	Did you check to see that the timer lamp lights up? Is the program timer set correctly?	Carefully read the instructions for setting the program timer on page 4.

Features

- Micro computer control panel does not require user supervision once set.
- Programable timer allows operator to prepare bread mix twelve hours before bread is desired.
- Transparent glass lid allows viewing of entire bread making process,
- High tech design; Euro-White finish.
- Oven and temperature sensors that adjust automatically to the type of bread being made.
- Non-stick inner pan enables user to mix, knead, raise and bake bread in one pan.
- Unique dough blade that lift and fold dough under as if being kneaded by hand to product a high quality finished product.
- Cool air ventilator cools temperature of bakery and finished product eliminating possibility of a soggy loaf of bread.
- Temperature sensor allows user to adjust for well baked, darker or lighter bread.
- Cookbook included.

Specifications

- Power Source: AC 120V/60Hz
- Power Consumption (Heater): 750W

Dimensions

- 10⁵/_s" W x 12"D x 14⁶/₈"H

Net Weight

- 18¹/₂lb3.

SPECIFICATIONS SUBJECT TO CHANGE WITHOUT NOTICE

FCC Information

This equipment has been tested and found to comply with the limits for a Class B digital device, pursuant to Part 15 of the FCC Rules. These limits are designed to provide reasonable protection against harmful interference in a residential installation. This equipment generates, uses, and can radiate radio frequency energy and, if not installed and used in accordance with the instructions, may cause harmful interference to radio communications. However, there is no guarantee that interference will not occur in a particular installation. If this equipment does cause harmful interference to radio or television reception, which can be determined by turning the equipment off and on, the user is encouraged to try to correct the interference by one or more of the following measures:

- Reorient or relocate the receiving antenna.
- Increase the separation between the equipment and receiver,
- Connect the equipment into an outlet on a circuit different from that to which the receiver is connected.
- Consult the dealer or an experienced radio/TV technician for help.

FCC Warning — This equipment may generate or use radio frequency energy. Changes or modifications to this equipment may cause harmful interference unless the modifications are expressly approved in the instruction manual. The user could lose the authority to operate this equipment if an unauthorized changes or modification is made.

The Bread Machine

LIMITED WARRANTY

What Is Covered and For How Long?

This warranty covers all defects in workmanship or materials in the mechanical and electrical parts contained in this Welbilt® product for a period of 12 months from the date of purchase. There will be no charge to the purchaser for parts and labor on items covered under the warranty during this period.

**YOU MUST KEEP YOUR ORIGINAL SALES SLIP
OR OTHER PROOF-OF-PURCHASE AS PROOF OF
THE DATE OF PURCHASE**

Who Is Covered?

The original retail purchaser of this Welbilt® product.

What Will Be Done?

We will repair or replace, at our discretion, any mechanical or electrical part which proves defective in normal household use during the applicable warranty period.

How Can You Get Service?

(1) Contact your nearest Welbilt® authorized Service Depot. For the name of your nearest authorized Service Depot, call Welbilt Appliance's Parts Department at (516)747-9595.

(2) If you have any difficulty in obtaining warranty service, contact the Director of Customer Relations, Welbilt Appliance, Inc., Parts & Service Dept. 25 Rose Place Garden City, NY 11040 (telephone number (516) 747-9595).
DO NOT RETURN THE PRODUCT TO WELBILT APPLIANCE, INC.

(3) All service must be performed by a Welbilt® authorized Service Depot or by Welbilt's Appliance Parts Department.

**THIS WARRANTY COVERS UNITS WITHIN THE
CONTINENTAL UNITED STATES AND
DOES NOT COVER**

- Damages from improper installation
- Damages in shipping
- Defects other than manufacturing
- Damages from misuse, abuse, accident, alteration, lack of proper care and maintenance or incorrect current or voltage
- Damages from other than household use
- Damage from service by other than an authorized dealer or service center
- Glass, trim or light bulbs
- Transportation and shipping

**THIS LIMITED WARRANTY IS GIVEN
IN LIEU OF ALL OTHER WARRANTIES,
EXPRESS OR IMPLIED,
INCLUDING THE WARRANTIES OF
MERCHANTABILITY AND FITNESS
FOR A PARTICULAR
PURPOSE.**

The remedy provided in this warranty is exclusive and is granted in lieu of all other remedies. This warranty does not cover incidental or consequential damages. Some states do not allow the exclusion of incidental or consequential damages, so the above limitation may not apply to you. Some states do not allow limitations on how long an implied warranty lasts, so the above limitation may not apply to you.

This warranty gives you specific legal rights, and you may also have other rights which vary from state to state.

More Tips for Easy Baking

Congratulations on owning a Welbilt automatic bread machine. For best results, carefully read the owner's manual and recipe booklet. We have also prepared the following hints and suggestions to assist you in making delicious loaves of homemade bread for your family and friends.

Yeast

Yeast is the leavening agent that causes the dough to expand or "rise". It is a living organism that is purchased in a dehydrated, dormant state. When mixed with warm liquids, yeast is brought back to life. It reacts with the sugar and starch in the recipe and subsequently develops gases which is what creates the small air pockets found in baked bread. Since making bread in a bread machine is different from the traditional handmade method, you should never dissolve the yeast in liquid. Just carefully follow the instructions given in the Welbilt recipe booklet for best results.

BreadFlour

Flour is an organic food product that contains many of the natural properties found in the wheat. Gluten, a natural protein found in wheat, is what makes bread dough elastic when efficiently kneaded. The higher gluten content of bread flour, which is available in most local supermarkets, is what produces high volume loaves of bread. As an organic food product, the gluten or protein level of flour can vary from harvest to harvest. In order to stabilize the protein levels of the flour, the mills add dough conditioners such as potassium bromate or ascorbic acid (a form of vitamin C).

continued

In Welbilt baking tests, *using flour milled from the 1992 harvest*, we consistently found that the flours that contain ascorbic acid provide the best results. You can determine whether or not the flour you are using contains ascorbic acid as a dough conditioner by reading the ingredient list on the flour bag. If you are unable to purchase flour with ascorbic acid, you can try adding 1 teaspoon of freshly squeezed lemon juice to the ingredients in the bread machine prior to pressing START. In fact, you may want to consider adding 1 teaspoon of lemon juice to all of your bread recipes to assure consistent baking results every time.

Yeast and Flour

Curiously enough, we have seen that certain brands and types of yeast and flour react differently when used together. The following are some of our suggestions to consider when making bread in a bread machine.

Yeast

Red Star Quick Rise

*Use only 1 1/2 teaspoons
in 3-cup-flour bread machines
and 1 teaspoon in 2-cup units.*

Red Star Active Dry

Fleischman Active Dry

Flour

Gold Medal Best For Bread

Or

Pillsbury Bread Flour

Gold Medal Best For Bread

Gold Medal Best For Bread

Or

Pillsbury Bread Flour

For additional baking assistance, please refer to your Owner's Manual or contact Welbilt at 516-365-5040 between 9 a.m. and 5p.m. Eastern time.